

memmert

Operating manual



INm
IFm

Incubator I
SingleDISPLAY

Table of Contents

1. About this Manual	5
2. Safety	7
2.1 Terms and Symbols Used	7
2.1.1 Terms Used.....	7
2.1.2 Symbols Used	7
2.2 Product Safety and Dangers.....	8
2.3 Requirements to be met by Operating Personnel.....	9
2.4 Responsibility of the Owner	9
2.5 Product Use	9
2.5.1 Intended Purpose	9
2.5.2 Intended Use.....	9
2.5.3 Improper Use	10
2.6 Changes and Alterations.....	10
2.7 Behaviour in case of Malfunctions and Irregularities	10
2.8 Switching off the Unit in an Emergency.....	10
3. Construction and Description	11
3.1 Design.....	11
3.2 Description of Function	11
3.3 Materials	12
3.4 Electrical Equipment.....	12
3.5 Connections and Interfaces	13
3.5.1 Electrical Connection.....	13
3.5.2 Communication Interfaces.....	13
3.6 Nameplate	13
3.7 Technical Data	14
3.8 Applied Directives and Standards.....	15
3.8.1 Declaration of Conformity.....	15
3.8.2 Material Compliance.....	16
3.9 Ambient Conditions.....	16
3.10 Scope of Delivery	17
4. Delivery, Transport and Setting Up	18
4.1 Safety.....	18
4.2 Delivery	18
4.3 Transport.....	18
4.4 Unpacking.....	19
4.5 Storage after Delivery	19
4.6 Setting Up.....	19
4.6.1 Preconditions.....	19
4.6.2 Installation Options	20

4.6.3	Anti-tilt bracket	21
4.6.4	Adjusting the Doors	21
5.	Putting into Operation	23
5.1	Putting into Operation for the First Time	23
5.2	Connecting the Unit to the Power Supply	23
5.3	Switching on Unit	24
6.	Operation and Control	25
6.1	Operating Personnel	25
6.2	Opening the Door	25
6.3	Loading the Appliance	26
6.4	Operating the Appliance	27
6.4.1	ControlCOCKPIT	27
6.4.2	Basic Operation	28
6.5	Operating Modes	29
6.5.1	Manual Mode	29
6.5.2	Digital Backwards Counter	30
6.6	Monitoring Function	31
6.6.1	Temperature Monitoring	31
6.6.2	Electronic Temperature Monitoring	31
6.6.3	Mechanical Temperature Monitoring: Temperature Limiter (TB)	32
6.7	Ending Operation	32
7.	Malfunctions, Warning and Error Messages	34
7.1	Warning Message of the Monitoring Function	34
7.1.1	Temperature Monitoring	34
7.2	Malfunctions, Operating Problems and Unit Errors	35
7.2.1	Power Failure	35
8.	Menu Mode	37
8.1	Overview	37
8.2	Basic Operation in Menu Mode Using the Example of Language Selection	37
8.3	Setup	38
8.3.1	Overview	38
8.3.2	IP Address and Subnet Mask	39
8.3.3	Unit	40
8.3.4	Temperature Monitoring	40
8.3.5	Timer Mode	41
8.3.6	Shelf Type (Grid or metal plate)	42
8.3.7	Remote Control	42
8.3.8	Gateway	42
8.4	Date and Time	42
8.5	Calibrate	43

8.5.1	Temperature Calibration	43
9.	Maintenance and Servicing	46
9.1	Cleaning	46
9.2	Regular Maintenance.....	46
9.3	Repairs and Service.....	47
10.	Storage, Transport and Disposal	48
10.1	Storage and Transport.....	48
10.2	Disposal	48

1. About this Manual

Purpose and target audience

This manual describes the design, function, transport, operation and maintenance of the product series Incubators Im. It is intended for use by trained personnel employed by the owner who are tasked with operating and/or maintaining the unit.

If you have been tasked with working on the unit, read this manual carefully before starting work. Familiarise yourself with the safety instructions. Only perform work that is described in this manual. If there is anything you do not understand, or if any information is lacking, ask your line manager or contact the manufacturer. Do not take any course of action on your own initiative.

Versions

The appliances are available in different equipment versions and sizes. If certain features or functions are only available in certain equipment versions, this is indicated at the relevant points in this manual.

The functions described in this manual relate to the most recent firmware version.

Due to the different equipment versions and sizes, the illustrations in this manual may be slightly different to your product. However, the product is identical in terms of its operation and function.

Further applicable documents

In addition to this manual, please observe the following documents:

- Service manual:
To carry out service and repair work you will require the separate service manual. Manuals can be requested from Memmert International After Sales or downloaded from **www.memmert.com**.
- AtmoCONTROL software manual
When operating the unit with the MEMMERT AtmoCONTROL PC software you will require the separate manual. You can find the manual for the AtmoCONTROL software in the AtmoCONTROL menu bar under 'Help'

Retaining and passing on this manual

This operating manual belongs to the unit and must always be kept in a location where it can be easily found by those working with the unit. It is the responsibility of the owner to ensure that persons who work on the unit know where this operating manual is. We recommend always storing it in a safe place near the unit.

Ensure that the manual is not damaged by heat or humidity. If the unit is sold or transported and re-installed at another location, this operating manual must be handed over with the unit. The current version of this operating manual is also available in PDF format at **www.memmert.com**.

Address and Customer Service

Manufacturer's address

Memmert GmbH + Co. KG
Äußere Rittersbacher Straße 38 D-91126 Schwabach Germany
Tel. +49 9122 925-0
E-mail: sales@memmert.com
www.memmert.com

International After Sales

Memmert GmbH + Co. KG
Willi-Memmert-Straße 90-96 D-91186 Büchenbach Germany
Tel. +49 9171 9792 911
E-mail: service@memmert.com
www.memmert.com
If you have any queries, please always quote the product number on the nameplate.

Shipping address for repairs

Memmert GmbH + Co. KG
Willi-Memmert-Straße 90-96 D-91186 Büchenbach Germany
Please contact our customer service before sending appliances for repair or before making returns, otherwise, we have to refuse acceptance of the shipment.

2. Safety

2.1 Terms and Symbols Used

In this manual and on the unit itself, certain recurring terms and symbols are used to warn you of hazards or give you information that is important in order to prevent injury or damage. To avoid accidents and damage, observe and follow these instructions. These terms and symbols are explained below.

2.1.1 Terms Used

	Warns of a dangerous situation that will result directly in death or serious (irreversible) injury.
	Warns of a dangerous situation that could result in death or serious physical injury.
	Warns of a dangerous situation that could result in moderate or minor physical injury.
	Warns of damage to property.

2.1.2 Symbols Used

	Risk of explosion		Gases / vapours
	Do not lift unit		Do not tilt
	Do not enter		Danger of electrocution
	Flammable substances		Hot surfaces
	General warning sign		Tipping hazard
	Disconnect the mains plug		Wear gloves
	Wear safety shoes		Observe information in separate manual

2.2 Product Safety and Dangers

The units described in this manual are technically sophisticated, manufactured using high-quality materials and subject to many hours of testing in the factory. They reflect the state of the art and comply with recognised technical safety regulations. However, there are still risks involved, even when the units are used as intended. These are described below.

DANGER



Risk of electric shock due to ingress of liquids

Penetration of liquid into the appliance can cause electric shocks and short circuits.

- Protect the appliance from splashing water.
- Switch off the appliance and disconnect the mains plug before carrying out any cleaning and maintenance work.
- The appliance must not be wet cleaned and disinfected. Allow the appliance to dry completely before putting it back into operation.
- When loading the chamber with wet material, insert the drip tray provided for the appliance size.

DANGER



Live parts

When covers are removed, live parts are exposed and contact with these parts may result in electric shock. Electric shock can have serious health consequences including death.

- Only authorised persons may carry out electrical installation work.
- Before starting work, disconnect the unit from the power supply.
- Ensure that the unit is fully de-energised.
- Secure the unit to prevent it from being switched on again.

DANGER



Danger of suffocation inside the appliance

If the appliances is a certain size, you can get accidentally locked in, which is potentially life-threatening.

- Do not climb into the appliance.
- Do not carry out cleaning work in the chamber alone.

WARNING



Poisonous or explosive vapours and gases

When loading the unit with an unsuitable load, poisonous or explosive vapours or gases may be produced. This could cause the unit to explode, and persons could be severely injured or poisoned.

- The unit may only be loaded with materials and substances which cannot form any toxic or explosive vapours at the set temperature and which cannot explode, burst or ignite.

WARNING



Overheating of the appliance when door is open

Leaving the door open during operation can cause the appliance to overheat or pose a fire hazard.

- Do not leave the door open during operation.

⚠ WARNING**Hot surfaces**

Depending on the operating situation, the unit and the load may be hot. Contact with hot surfaces may have serious health consequences due to burns!

- Allow the unit to cool down.
- Wear heat-resistant protective gloves when carrying out work.
- Check the temperature of surfaces before touching them.

If a serious incident occurs in combination with this medical device - such as the death of a patient, user or third party - you must promptly notify Memmert GmbH + Co. KG and the relevant national authority.

2.3 Requirements to be met by Operating Personnel

The appliance may only be operated and maintained by persons who are of legal age and have been instructed accordingly. It is intended to be operated and maintained by trained personnel employed by the owner.

Repairs may only be performed by qualified electricians. The guidelines in the separate service manual must be observed.

2.4 Responsibility of the Owner

The owner of the unit

- is responsible for the flawless condition of the unit and for operating it in accordance with its intended use;
- is responsible for ensuring that persons who operate or service the unit are qualified to do this, have been instructed accordingly and are familiar with these operating instructions;
- must know the applicable guidelines, requirements and operational safety regulations, and train staff accordingly;
- is responsible for ensuring that unauthorised persons cannot access the unit;
- is responsible for ensuring that the maintenance plan is adhered to and that maintenance work is properly carried out;
- has to ensure that the unit and its surroundings are kept clean and tidy, for example through corresponding instructions and inspections;
- is responsible for ensuring that personal protective clothing is worn by operating personnel, e.g. work clothes, safety shoes and protective gloves.

2.5 Product Use

2.5.1 Intended Purpose

Intended purpose according to the Regulation (EU) 2017/745 of the European Parliament and of the Council on medical devices:

The appliance can be used to heat fango, silicate and APS packs for physical therapy and keep them warm.

2.5.2 Intended Use

This appliance is exclusively intended for heating up non-explosive and non-combustible substances and objects.

2.5.3 Improper Use

Any other use is improper and may result in danger and damage.

The appliance is not explosion-proof (does not comply with the German occupational health and safety regulation VBG 24). Only materials and substances which cannot form any toxic or explosive vapours at the set temperature and which cannot explode, burst or ignite may be put in the appliance.

The appliance must not be used to dry, vaporise or brand materials whose procurement or constituents pose a risk of fire and/or explosion, especially if the solvents of these materials could form an explosive mixture when combined with air. If you are not sure whether a given material has these characteristics, you must not put it in the appliance. Potentially explosive gas-air mixtures must not be able to form in the working chamber or in the direct vicinity of the appliance.

2.6 Changes and Alterations

Unauthorised changes or alterations must not be made to the appliance. Parts that are not approved by the manufacturer must not be mounted or built in.

Unauthorised changes or alterations result in the CE declaration of conformity losing its validity, and the appliance must no longer be operated.

The manufacturer is not liable for any damage, danger or injuries that emanating from unauthorised changes or alterations, or from non-compliance with the provisions in this manual.

2.7 Behaviour in case of Malfunctions and Irregularities



The unit must only be used in a flawless condition. If you, as the operator, notice irregularities, malfunctions or damage, immediately turn off the unit and inform your line manager.



You can find information on troubleshooting in the chapter ▶7 Malfunctions, Warning and Error Messages.

See also

📖 Malfunctions, Warning and Error Messages [▶ 34]

2.8 Switching off the Unit in an Emergency

⚠️ WARNING



Hot surfaces

Depending on the operating situation, the unit and the load may be hot. Contact with hot surfaces may have serious health consequences due to burns!

- Allow the unit to cool down.
- Wear heat-resistant protective gloves when carrying out work.
- Check the temperature of surfaces before touching them.

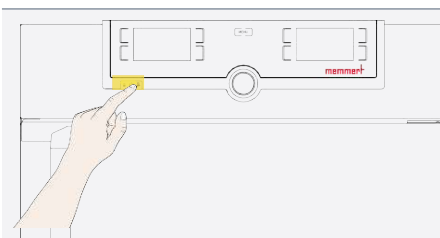

1. Press the main switch on the appliance.
 2. Unplug the mains plug from the power source.
- ⇒ This disconnects the appliance from the power supply at all poles.

3. Construction and Description

3.1 Design



1 ControlCOCKPIT with capacitive function keys and LCD displays	2 Main switch
3 Interior fan (only for IF appliances)	4 Grid
5 Chamber	6 Nameplate
7 Door handle	8 Turn control with confirmation key

3.2 Description of Function

Appliances of the xN type series feature natural ventilation (convection). For the xF type series, air is circulated by a fan mounted on the back panel of the chamber ③. It offers a higher air flow and more intense forced air circulation in the horizontal plane than natural convection.

Irrespective of whether the ventilation is achieved by convection or is fan-assisted, supply air ⑤ is preheated in a pre-heating chamber ④. The preheated air is introduced into the interior of the chamber through ventilation slots in the sides. The supply and exhaust air ② volume (air exchange) is controlled by the air flap ① on the rear panel of the appliance.

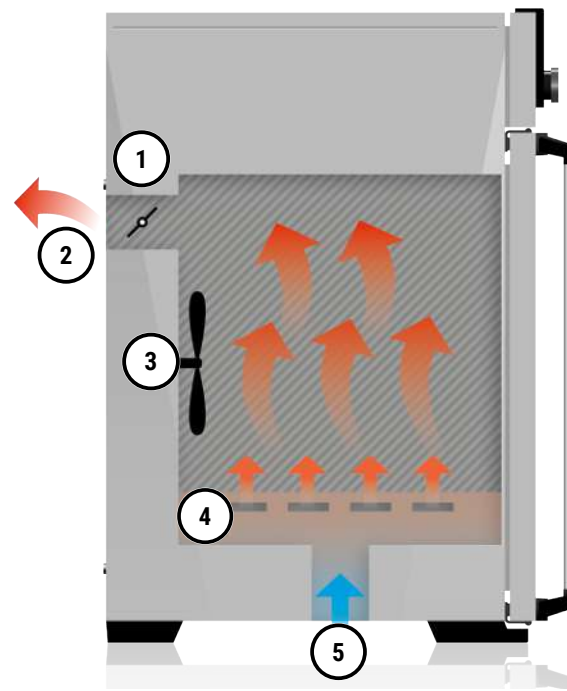

1 Air flap	2 Exhaust air
3 Fan	4 Pre-heating chamber
5 Fresh air	

3.3 Materials



The chamber load of the appliance must be carefully checked for chemical compatibility with the indicated materials.

Components	Material
Housing (lid + side panels)	Stainless steel 1.4016 – ASTM 430
Housing (back panel)	Galvanised steel plate
Chamber (incl. cover)	Stainless steel 1.4301 – ASTM 304
Accessories (perforated shelf, grid)	Stainless steel 1.4301 – ASTM 304
Door seal	Silicone
Inner glass door	Glass
Battery (ControlCOCKPIT)	Type: CR2030 Chemical system: Li-Mn-based battery

3.4 Electrical Equipment

- Operating voltage and current consumption: See ▶3.6 Nameplate or ▶3.7 Technical Data
- Degree of protection IP 20 acc. to DIN EN 60529
- Protection class I, i.e. operating insulation with PE conductor connection according to EN 61010
- Interference suppression acc. to EN 55011 class B
- Appliance fuse: Fusible link 250 V/15 A quick-blow
- The temperature controller is protected by a miniature fuse 100 mA (160 mA at 115 V)

See also

 Technical Data [▶ 14]

 [Nameplate](#)  13]

3.5 Connections and Interfaces

Where appliances of Memmert GmbH + Co. KG provide the option of connecting to the network environment, Internet, etc., the manufacturer cannot be held responsible if the owner and/or user decides to do so.

Internet security is not taken into consideration in the design process of the appliances, nor is this discernible in the intended purpose. Every owner or user must always bear in mind that if they connect the appliance to the Internet, they do so entirely at their own risk and/or must take suitable mitigating measures. The manufacturer has no experience and/or empirical data to support any purpose of this kind.

3.5.1 Electrical Connection

This unit is designed for operation on an electrical power system with a maximum system impedance Z_{max} at the point of transfer (service line) of 0.292 Ohm. The operator must ensure that the unit is only operated on an electrical power system that meets these requirements.

If necessary, ask your local utility company what the system impedance is. Observe the country-specific regulations when making connections (e.g. in Germany DIN VDE 0100 with earth leakage circuit breaker).

3.5.2 Communication Interfaces

The communication interfaces are intended for appliances which meet the requirements of IEC 60950-1.

Ethernet interface



You will find a description of how to transfer programs via Ethernet in the AtmoCONTROL software manual.



The unit can be connected to a network via the Ethernet interface, so that you can transfer programmes created with the AtmoCONTROL software to the unit and export logs.

For identification purposes, each unit connected must have its own unique IP address. A description of how to set the IP address is provided in chapter [▶8.3.2 IP Address and Subnet Mask](#).

The unit can be directly connected to a computer / laptop using an optional USB to Ethernet converter (see [▶3.10 Scope of Delivery](#)).

See also

 [IP Address and Subnet Mask](#)  39]

 [Scope of Delivery](#)  17]

3.6 Nameplate

The nameplate provides information about the appliance model, manufacturer and technical data. It is attached to the front of the appliance, on the right behind the door (see [▶3.1 Design](#)).

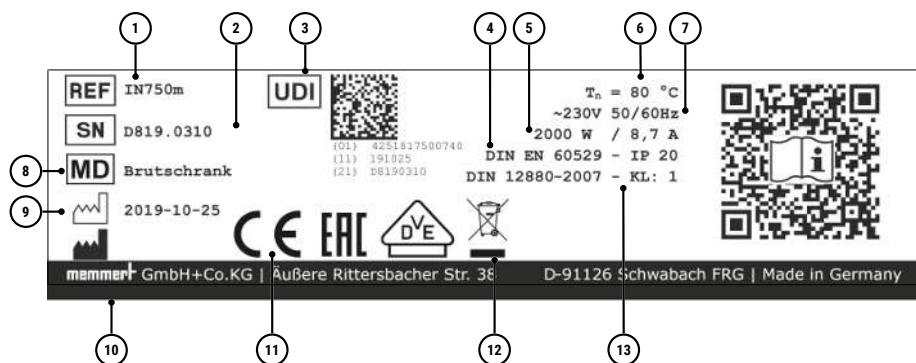

1	Type designation	2	Appliance number
3	UDI information	4	Degree of protection
5	Connected loads / power ratings	6	Temperature range
7	Operating voltage	8	Product name
9	Year of production	10	Manufacturer's address
11	Conformity	12	Information regarding disposal
13	Applicable standard		

See also

Design [▶ 11]

3.7 Technical Data

Appliance size			30	55	75	110	160	260	450	750	
Stainless steel interior	Volume		l	32	53	74	108	161	256	449	749
	Width	A	mm	400	400	400	560	560	640	1,040	1,040
	Height	B	mm	320	400	560	480	720	800	720	1,200
	Depth	C	mm	250	330	330	400	400	500	600	600
	Max. number of shelves		Pc	3	4	6	5	8	9	8	14
	Max. loading per shelf		kg	20	20	20	20	20	20	30	30
	Max. loading per appliance		kg	60	80	120	175	210	300	300	300
	Max. loading per insertable/removable drip tray		kg	1.5	1.5	1.5	3.0	3.0	4.0	8.0	8.0
	Max. loading per bottom drip tray		kg	1.5	1.5	1.5	3.0	3.0	4.0	8.0	8.0
Patterned stainless steel housing	Width	D	mm	585	585	585	745	745	824	1,224	1,224
	Height	E	mm	704	950	1,130	1,050	1,300	1,380	1,440	1,910
	Depth	F	mm	434	514	514	584	584	684	784	784
Temperature	Operating temperature range		°C	at least 5 (IN/INplus) 10 (IF/IFplus) above room temperature up to +80							
	Setting temperature range		°C	+20 up to +80							
	Adjustment precision		°C	0.1							
Further data	Power consumption (50/60 Hz)	230 V	W	1,600	1,000	1,250	1,400	1,600	1,700	1,800	2,000
		115 V	W	800	900	900	900	900	900	1,500	1,800
	Max. current consumption (50/60 Hz)	230 V	A	7.0	4.3	5.4	6.1	7.0	7.0	7.8	8.7
		115 V	A	7.0	7.8	7.8	7.8	7.8	7.8	13.0	15.6
Packaging data	Net weight		kg	48	57	66	76	96	110	161	217
	Gross weight		kg	64	76	85	101	122	161	227	288
	Width		mm	660	730	730	830	830	930	1,330	1,330

Appliance size				30	55	75	110	160	260	450	750
	Height		mm	890	950	1,130	1,050	1,300	1,380	1,440	1,910
	Depth		mm	650	670	670	800	800	930	1,050	1,050

¹ With the interior lighting on, the minimum temperature might not be reached.

² Up to +250 °C if your appliance is equipped with a glass door

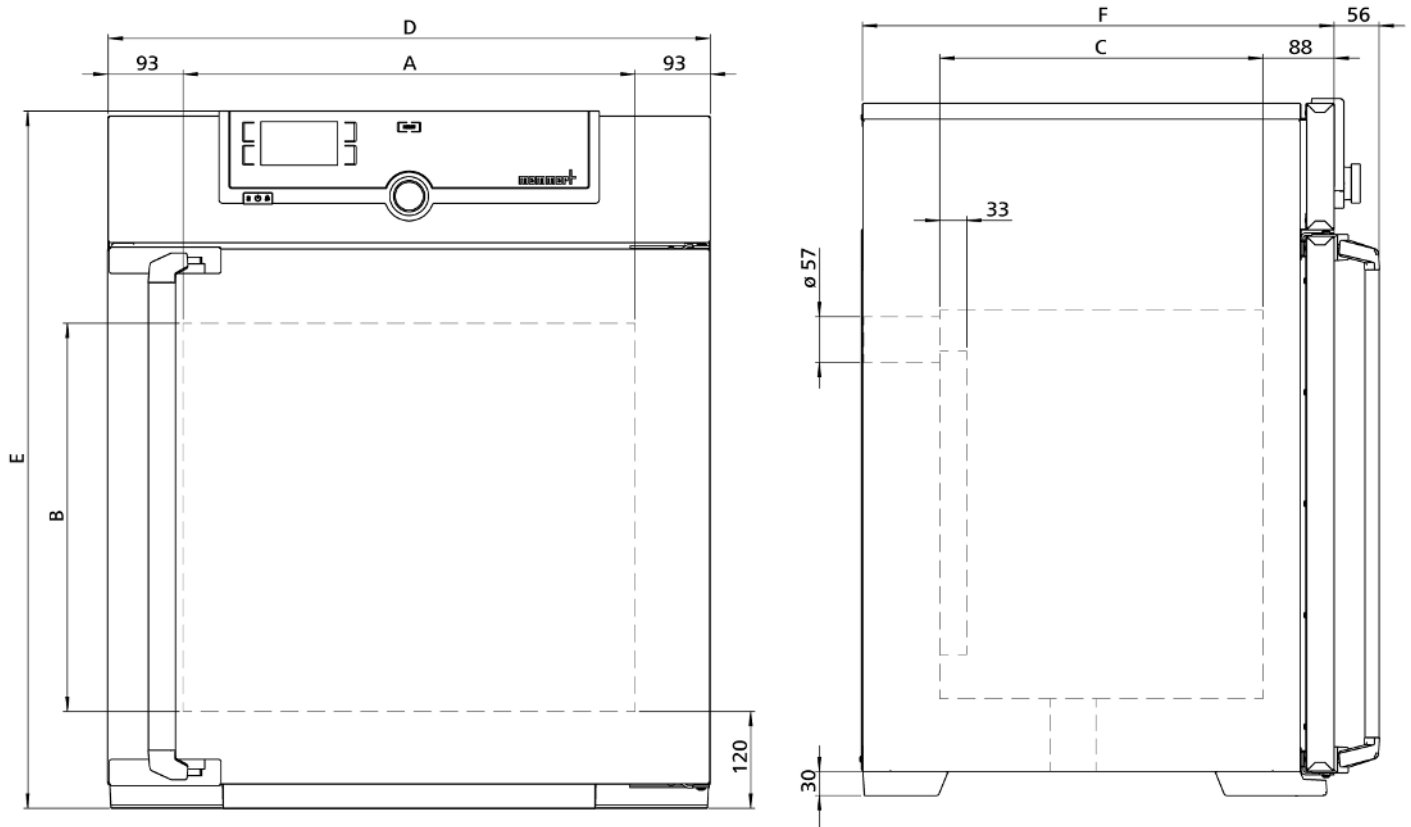

3.8 Applied Directives and Standards

3.8.1 Declaration of Conformity



You can download the EC declaration of conformity of the appliance online:

English: <http://www.memmert.com>

German: <http://www.memmert.com>

Based on the standards and guidelines listed below, the products described in this manual carry a CE mark from Memmert:

Directive (EU) 2017/745

Regulation (EU) 2017/745 on medical devices, amendment to Directive 2001/83/EC, Regulation (EC) No. 178/2002 and Regulation (EC) No. 1223/2009 and repealing Council Directives 90/385/EEC and 93/42/EEC.

Directive 2011/65/EU

Directive 2011/65/EU of the European Parliament and of the Council on the restriction of the use of certain hazardous substances in electrical and electronic equipment.

3.8.2 Material Compliance

We confirm that we always draw the attention of our suppliers to the legal restrictions on materials in accordance with our **Company Standard for Material Compliance of Memmert GmbH + Co KG** to ensure they take the original publications by the legislative authority into consideration at all times. The suppliers and deliveries must comply with all material compliance requirements which are relevant or specified in the company standard. By taking this approach, and by making our own observations, we are always able to stay abreast of developments to the best of our knowledge and ability.

In accordance with the REACH regulation and the RoHS guideline, Memmert provides information on the chemical substances in Memmert appliances online at:

www.memmert.com

3.8.2.1 REACH information of Memmert GmbH + Co. KG acc. to Regulation (EG) No. 1907/2006, Art. 33

Based on current knowledge, we confirm that products or sub-products containing substances of very high concern (SVHC in the specified components) in the Candidate List with concentrations higher than 0.1 mass % are installed in the appliances we supply:

Appliance component	Substance in the Candidate List SVHC	CAS No.
Fan units	Lead	■ 7439-92-1
Blue housing protection film	Tris(4-nonylphenyl, branched and linear) phosphite	■ 26523-78-4 ■ 3050-88-2 ■ 31631-13-7 ■ 106599-06-8
Seal inserts made of NBR	2,2'-Methylenbis(4-methyl 6-tert-butylphenol)	■ 119-47-1

Further information related to the REACH information of Memmert GmbH + Co. KG acc. to Regulation (EG) No. 1907/2006, Art. 33, can be found under:

Material compliance | General REACH and RoHS customer information

3.8.2.2 RoHS Information of Memmert GmbH + Co. KG acc. to Directive 2011/65/EU and Delegated Directive 2015/863

We confirm that we comply with the substance restrictions in accordance with 2011/65/EU for the supplied products, accessories and spare parts. With regard to the substance lead, we and/or our suppliers make use of the applications exempted from the restriction for lead stated in appendix III in a credible, trustworthy manner.

Further information related to the RoHS information for Memmert GmbH + Co. KG acc. to Directive 2011/65/EU and Delegated Directive 2015/863 can be found under:

Material compliance | General REACH and RoHS customer information

3.9 Ambient Conditions

- The unit must only be used in closed rooms and in the ambient conditions listed below:

Ambient temperature	+5 °C to +40 °C
Air humidity	max. 80% non-condensing
Overvoltage category	II
Contamination level	2
Installation altitude a.s.l.	max. 2000 m a.s.l.

- The unit may not be used in Ex zones. The ambient air must not contain explosive dusts, gases, vapours or gas-air mixtures. The unit is not explosion-proof.
- Heavy dust production or aggressive vapours in the vicinity of the unit could lead to sedimentation in the interior and, as a consequence, could result in short circuits or damage to electrical parts. For this reason, sufficient measures to prevent large accumulations of dust or aggressive vapours should be taken.

3.10 Scope of Delivery

Standard delivery

- Mains connection cable
- One or two insertable/removable grids
- Anti-tilt bracket
- Operating manual
- Calibration certificate

Optional accessories

- AtmoCONTROL software for reading out and processing log data.
- Ethernet to USB converter. Makes it possible to connect the Ethernet port of the appliance to the USB port of a computer/laptop.
- Reinforced grid with a load capacity of 60 kg (from appliance size 110).

4. Delivery, Transport and Setting Up

4.1 Safety

⚠ CAUTION



Lifting the appliance incorrectly

The appliance is heavy. The appliance is heavy, so you could injure yourself if you try to lift it on your own.

- Make sure that a sufficient number of people are on hand to lift and carry the appliance.
- Larger appliances must not be carried, and only transported by pallet truck or forklift truck.

30	55	75	110	160	260	450	750

⚠ CAUTION



Crushing hazard due to heavy equipment

The unit is heavy. Crushing injuries to hands or feet can occur when transporting and installing the unit.

- Wear protective gloves and safety boots.
- Grab hold of the sides of the unit to carry it.

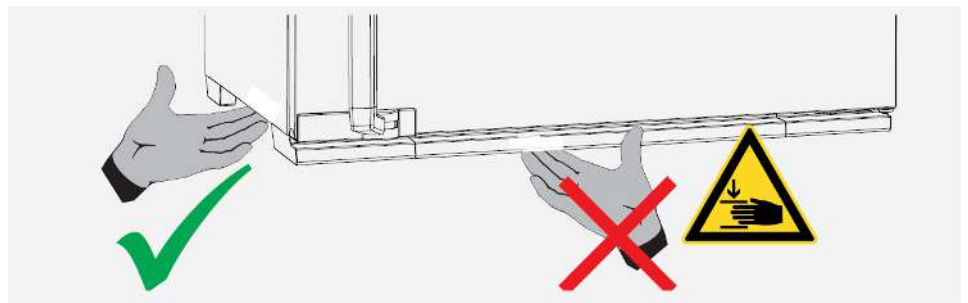

⚠ CAUTION



Risk of injury due to the appliance falling over during transport

The appliance is heavy. The appliance could fall over and seriously injure you.

- Never tilt the appliance and only transport it in the upright position without load (except for standard accessories such as grids or shelves).
- Appliances with castors always have to be moved by at least two people.

4.2 Delivery

The appliance is supplied packed in cardboard on a wooden pallette.

4.3 Transport

The unit can be transported in different ways depending on its size:

- With a forklift truck or pallet truck; move the forks of the truck entirely under the pallet
- Carrying; lift the unit at the designated handle positions

- If the appliance has its own castors, also release the locking device on the (front) castors

4.4 Unpacking

- Do not unpack the appliance until you reach the installation site.
- Remove the cardboard packaging by pulling it upwards or carefully cutting along an edge or unscrew and remove wooden crate.

Checking for completeness and transport damage

- Check the delivery note to ensure the delivery is complete.
- Check the unit for damage.

If you notice deviations from the scope of delivery, damage or anything unusual, do not put the unit into operation and inform the haulage company and the manufacturer.

Removing the transportation lock

- Remove the transportation lock. It is located between the door hinge, door and frame and has to be removed after opening the door.

Disposing of packaging material

- Dispose of the packaging material (cardboard, wood, foil) in accordance with the applicable disposal regulations for the respective material in your country.

4.5 Storage after Delivery

If the unit is initially to be stored after delivery:

- Observe storage conditions (see ►10.1 Storage and Transport)

See also

 Storage and Transport [► 48]

4.6 Setting Up

WARNING



Danger of tipping due to the appliance's centre of gravity

Due to its centre of gravity, the appliance could tip forwards and injure you or someone else.

- Always attach the appliance to a wall with the anti-tilt bracket.
- In case there is not enough space to fasten the appliance to a wall, do not put the appliance into operation and do not open the door.
- Contact Memmert service.

4.6.1 Preconditions

- ✓ The installation site must be flat and horizontal and must be able to reliably bear the weight of the unit (see ►3.7 Technical Data). Place the unit on a heat-resistant, fireproof and non-flammable surface.
- ✓ A 230 V or 115 V power connection must be available at the installation site, depending on the version (see ►3.6 Nameplate).
- ✓ The distance between the wall and the rear panel of the appliance must be at least 15 cm.

- ✓ The clearance from the ceiling must not be less than 20 cm and the side clearance from walls or nearby appliances must not be less than 5 cm. Sufficient air circulation in the vicinity of the appliance must be guaranteed at all times.
- ✓ For appliances with castors or for appliances standing on sub frames with castors, always position the castors in a forward direction and lock the castor brakes to ensure that the appliances remain securely in place.
- ▶ Place the unit in the designated position as shown below.

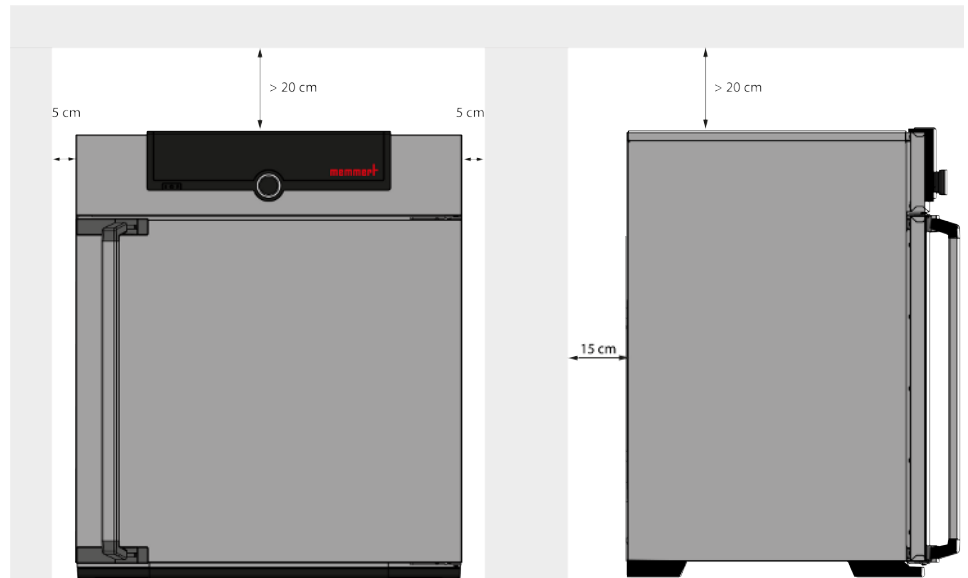

See also

- 📄 [Technical Data \[▶ 14\]](#)
- 📄 [Nameplate \[▶ 13\]](#)

4.6.2 Installation Options

Setting up	Comments	30	55	75	110	160	260	450	750
Floor		✓	✓	✓	✓	✓	✓	✓	✓
Table	 Check the load-bearing capacity first	✓	✓	✓	✓	✗	✗	✗	✗
Stacked	 No more than two appliances; mounting material (feet) provided	✓	✓	✓	✓	✗	✗	✗	✗
Wall mounting bracket	 Separately packaged fastening material is included in the scope of delivery. Observe the assembly instructions provided.	✓	✓	✓	✓	✓	✗	✗	✗

Setting up	Comments	30	55	75	110	160	260	450	750
Sub frame 	with/without castors	✓	✓	✓	✓	✓	✓	✓	✗
Castor frame 		✓	✓	✓	✓	✓	✓	✗	✗
Height-adjustable feet 		✓	✓	✓	✓	✓	✓	✓	✓

4.6.3 Anti-tilt bracket

Attach the appliance to a wall with the anti-tilt bracket. The anti-tilt bracket is included in the scope of delivery.

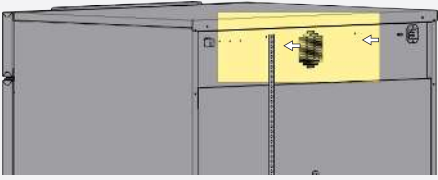

1. Screw the anti-tilt bracket to the back of the appliance as illustrated.



Depending on the ambient conditions, the anti-tilt bracket can be fastened at one of the two holes provided in the appliance.

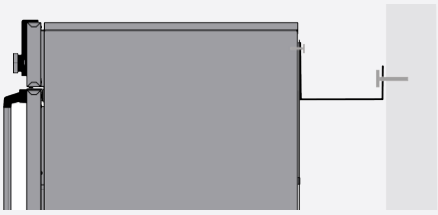

2. Bend the anti-tilt bracket up by 90° to achieve the required clearance from the wall (observe the minimum clearance).

3. Find a suitable wall, drill a hole, insert a plug and screw on the anti-tilt bracket.

4.6.4 Adjusting the Doors

You can adjust the doors if necessary, for example if they are warped due to uneven flooring. There are two adjusting screws on each door for this purpose; one at the top and one at the bottom.

First, adjust the setting at the top of the door and, if this is not sufficient, adjust the bottom.



A service video which explains how to adjust the door is available:
www.memmert.com/de/downloads/media/service-videos/

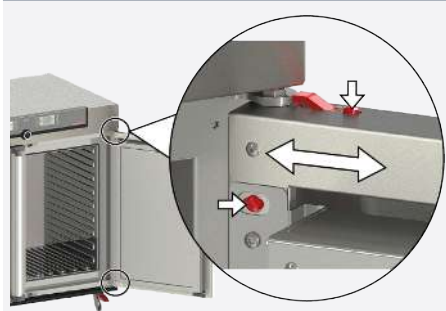

1. Open the door.
2. Loosen the screws.
3. Adjust the position of the door.
4. Tighten the screws again.
5. Check the position of the door.
6. Readjust if required.

5. Putting into Operation

5.1 Putting into Operation for the First Time

⚠ WARNING



Condensation in the electrical components may cause short circuits.

Due to temperature fluctuations during transport, condensation may form inside the unit.

- After transporting or storing the unit in humid conditions, remove it from its packaging and allow it to acclimatise for at least 24 hours in normal ambient conditions.
- Do not connect the unit to the power supply during this time.

NOTICE



When putting the unit into operation for the first time, do not leave it unattended until it has reached a steady state.

- Please observe the national regulations when connecting the unit.
- Observe the connected loads and power ratings (see ▶3.6 Nameplate and ▶3.7 Technical Data).
- Be sure to establish a safe PE conductor connection.

See also

- 📄 Nameplate [▶ 13]
- 📄 Technical Data [▶ 14]

5.2 Connecting the Unit to the Power Supply



Observe the country-specific regulations when making connections (e.g. DIN VDE 0100 with earth leakage circuit breaker, in Germany).

Observe the connected loads and power ratings (see ▶3.6 Nameplate and ▶3.7 Technical Data).

Be sure to establish a safe PE conductor connection.

115 / 230 V appliances:



Route the power cable so that

- nobody can trip over it.
- it cannot come into contact with any hot parts.
- it is easily accessible at all times and the plug can be pulled out quickly in the event of a fault or emergency, for example.

See also

- 📄 Nameplate [▶ 13]
- 📄 Technical Data [▶ 14]

5.3 Switching on Unit

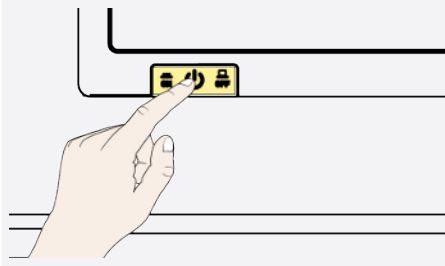

1. Switch on the appliance by pressing the main switch on the front of the appliance.
⇒ The starting process is shown by three animated white dots  (see ▶7.1 Warning Message of the Monitoring Function).



After the first start-up, the appliance display is set to English by default. You can change the language as described in chapter ▶8.2 Basic Operation in Menu Mode Using the Example of Language Selection. However, to get a basic overview of operating the appliance, you should read the following chapter first.

See also

- Basic Operation in Menu Mode Using the Example of Language Selection [▶ 37]
- Warning Message of the Monitoring Function [▶ 34]

6. Operation and Control

6.1 Operating Personnel

The appliance may only be operated by persons who are of legal age and have been instructed accordingly. Personnel who are to be trained, instructed or who are undergoing general training may only work with the appliance under constant supervision of an experienced person.

6.2 Opening the Door

⚠ DANGER



Danger of suffocation inside the appliance

If the appliances is a certain size, you can get accidentally locked in, which is potentially life-threatening.

- Do not climb into the appliance.
- Do not carry out cleaning work in the chamber alone.

⚠ WARNING



Overheating of the appliance when door is open

Leaving the door open during operation can cause the appliance to overheat or pose a fire hazard.

- Do not leave the door open during operation.

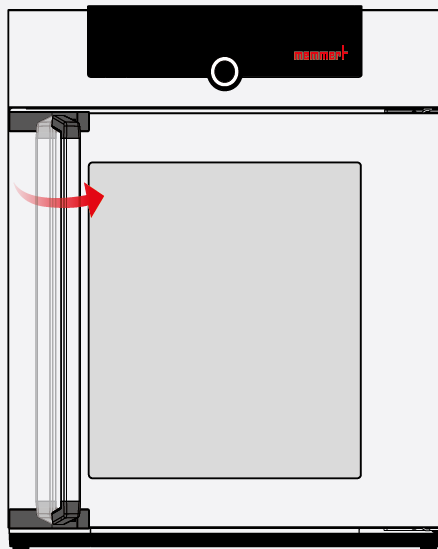

1. To open the door, pull the door handle to the side.

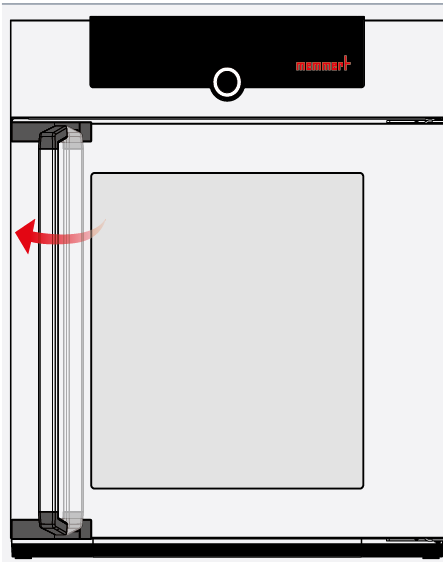

2. To close the door, push the door closed and push the door handle to the side.

6.3 Loading the Appliance

WARNING



Poisonous or explosive vapours and gases

When loading the unit with an unsuitable load, poisonous or explosive vapours or gases may be produced. This could cause the unit to explode, and persons could be severely injured or poisoned.

- The unit may only be loaded with materials and substances which cannot form any toxic or explosive vapours at the set temperature and which cannot explode, burst or ignite.

NOTICE



Chemical compatibility of the chamber load

Chemical incompatibility may result in damage to the appliance.

- Check the chamber load for chemical compatibility with the materials of the appliance (see ▶3.3 Materials).



Insert the metal grids or shelves. The maximum number of grids / shelves and the load capacity are specified in the ▶3.7 Technical Data.

- To achieve the most efficient temperature distribution, the type of insert used – grid or shelf – has to be set in the menu under **SETUP**.

The appliance must not be loaded too densely to ensure that air can circulate freely inside the chamber. If the chamber loading is unfavourable (chamber too densely packed), the set temperature may be exceeded or it may take longer until it is reached.

- Do not place any of the chamber load on the bottom, touching the side walls or right below the ceiling of the chamber.
- See also the “correct loading” sticker on the appliance.

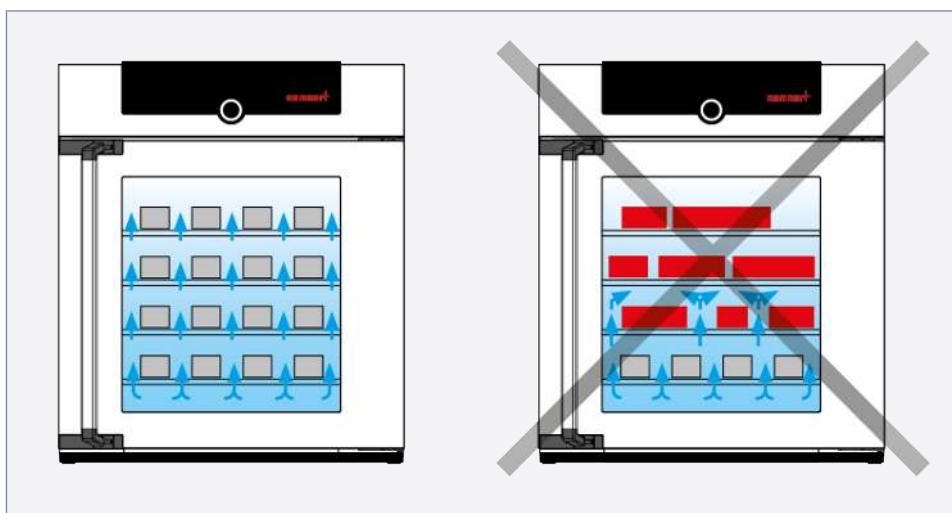

See also

- ▣ Materials [▶ 12]
- ▣ Technical Data [▶ 14]

6.4 Operating the Appliance

6.4.1 ControlCOCKPIT

In manual operation, the desired parameters are entered at the ControlCOCKPIT on the front of the appliance. You can also make basic settings here (**menu mode**). Warning messages are also displayed, e.g. if the temperature is exceeded.

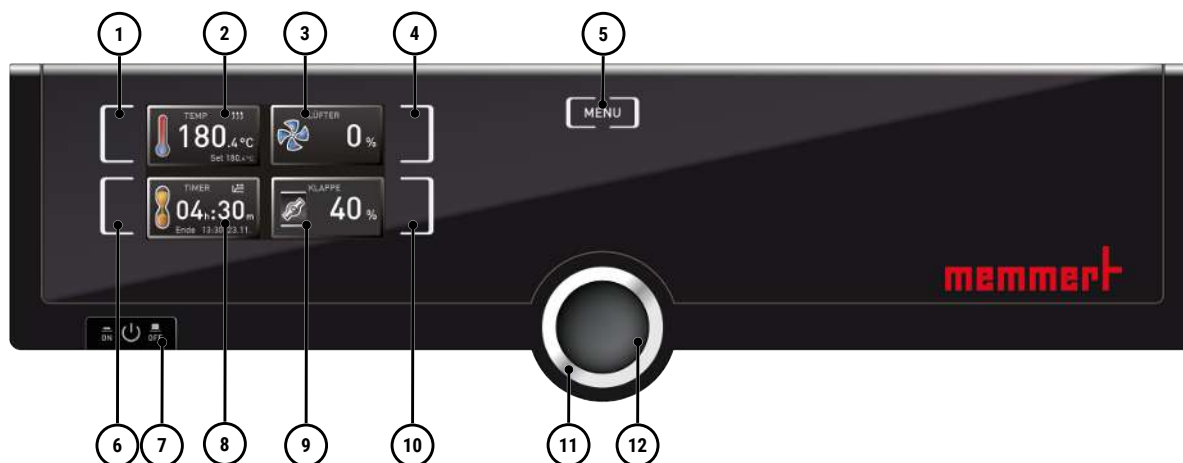

1	Activation key for temperature setpoint input	2	Setpoint and actual temperature display
3	Fan speed display	4	Activation key for fan speed setting
5	Switch to menu mode	6	Activation key for digital backwards counter with target time setting, adjustable from 1 minute to 99 days
7	Main switch	8	Display of digital backwards counter with target time setting, adjustable from 1 minute to 99 days
9	Air flap position display	10	Activation key for air flap position adjustment
11	Turn control for setpoint adjustment	12	Confirmation key (applies setting made with the turn control)

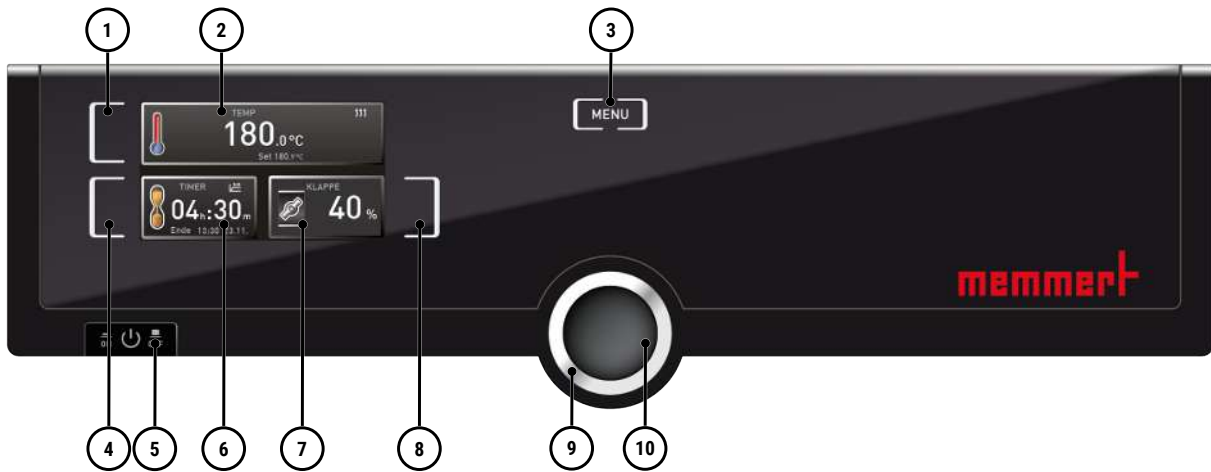

1	Activation key for temperature setpoint input	2	Setpoint and actual temperature display
3	Switch to menu mode	4	Activation key for digital backwards counter with target time setting, adjustable from 1 minute to 99 days
5	Main switch	6	Display of digital backwards counter with target time setting, adjustable from 1 minute to 99 days
7	Air flap position display	8	Activation key for air flap position adjustment
9	Turn control for setpoint adjustment	10	Confirmation key (applies setting made with the turn control)

6.4.2 Basic Operation

In general, all settings are made as follows:

	<p>Activate the desired parameter (e.g. temperature):</p> <ol style="list-style-type: none"> To do so, press the activation key to the left or right of the respective display. <ul style="list-style-type: none"> ⇒ The activated display is outlined in colour, the other displays are dimmed. ⇒ The setpoint value (Set) is highlighted in colour.
	<ol style="list-style-type: none"> You can adjust the setpoint (e.g. to 180 °C) by turning the turn control anti-clockwise or clockwise.
	<ol style="list-style-type: none"> Save the set value by pressing the confirmation key. <ul style="list-style-type: none"> ⇒ The display returns to normal and the appliance starts controlling with reference to the defined setpoint value. ⇒ Additional parameters and functions can be set accordingly.
	<p>If no new values are entered or confirmed for approx. 30 seconds, the appliance automatically restores the former values.</p>

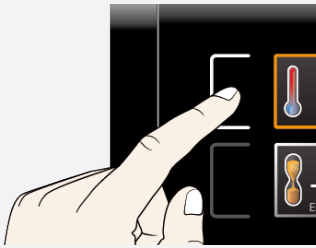

If you want to discard the settings:

4. Press the activation key on the left or right of the display that you want to exit.
 - ⇒ The appliance restores the former values.
 - ⇒ Only the settings that you have saved by pressing the confirmation key will be applied.

6.5 Operating Modes

Manual mode

The appliance runs continuously with the values set at the ControlCOCKPIT.

- See ▶6.5.1 Manual Mode

Timer mode

Operation with digital backwards counter with target time setting, adjustable from 1 minute to 99 days (Timer): The appliance runs at the values set until the set time has elapsed.

- See ▶6.5.2 Digital Backwards Counter

Remote control mode

Via remote control

- See ▶8.3.7 Remote Control

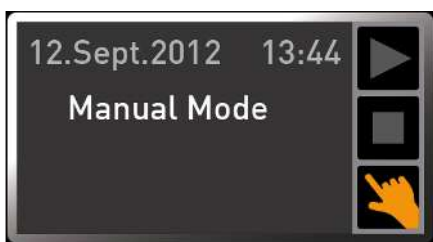

The status display shows the current operating mode or operating state of the appliance. The current operating state is indicated by colour and text display:

- ▶ Appliance is in programme mode
- Programme stopped
- ✎ Appliance is in manual mode

The example on the right shows the appliance in manual mode, as indicated by the coloured hand symbol.

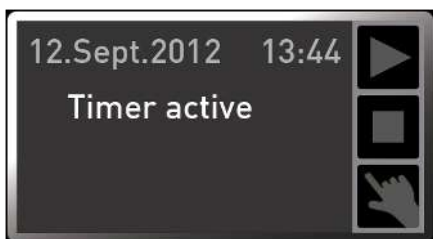

When the appliance is in timer mode, Timer active is displayed.

See also

- Manual Mode [▶ 29]
- Digital Backwards Counter [▶ 30]
- Remote Control [▶ 42]

6.5.1 Manual Mode

In this operating mode, the appliance runs continuously with the values set on the ControlCOCKPIT.

As described in chapter ▶6.4.2 Basic Operation, you can set the following parameters after pressing the corresponding activation key (in any sequence):

Temperature



Heating operation is indicated by the $\uparrow\uparrow\uparrow$ symbol.
 You can display the temperature in °C or °F.
 The setting range depends on the appliance (see ▶3.6 Nameplate and ▶3.7 Technical Data).

Air flap position



Setting range: 0% (closed, recirculating operation) up to 100% (fully open, fresh air operation) in 10% increments.

Fan speed



(only for appliances with interior fan)
 Adjustment options: 0 to 100% in 10% increments

See also

- ▣ Basic Operation [▶ 28]
- ▣ Nameplate [▶ 13]
- ▣ Technical Data [▶ 14]

6.5.2 Digital Backwards Counter



In timer mode, you can adjust the time the appliance runs at the set value. The appliance has to be in manual operating mode for this.

Up to a duration of 23 hours 59 minutes, the time is displayed in hh:mm (hours:minutes) format. For 24 hours and more, the format dd:hh (days:hours) is used. The maximum duration is 99 days and 00 hours.

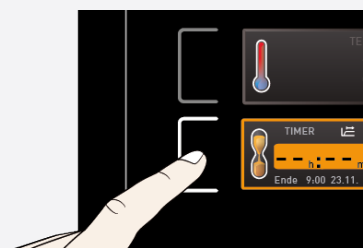

1. Press the activation key to the left of the timer display.
 ⇒ The timer display is activated.



2. Turn the turn control until the desired duration is displayed.
 ⇒ The anticipated end time is shown beneath, in smaller digits.

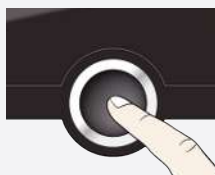

3. Press the confirmation key to confirm.
 ⇒ The display now shows the remaining time in large digits and the anticipated end time in smaller digits beneath.
 ⇒ The status display shows "Timer active".

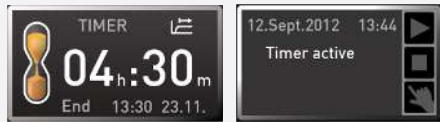

4. Now, as described in ▶6.4.2 Basic Operation, set the individual reference values to be used by the appliance during operation.
 - ⇒ The change takes effect immediately.



The set values can be changed at any time while the timer runs down.



In **Setup**, you can choose if the timer should run setpoint-dependent or not, in other words, whether the timer should not start until a tolerance band around the setpoint temperature is reached or if it should start right after activation.

The symbol  on the timer display indicates that the timer is setpoint-dependent.



Once the timer has elapsed, the display shows 00h:00m.

- All functions are switched off.
- In addition, an alarm sounds, and can be turned off by pressing the confirmation key.

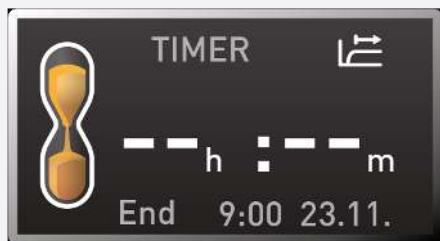

5. To switch off the timer, press the activation key again to display the timer.
6. Turn the turn control to reduce the runtime until --:-- is displayed.
7. Press the confirmation key to apply the setting.

See also

 Basic Operation [▶ 28]

6.6 Monitoring Function

6.6.1 Temperature Monitoring

The appliance is equipped with multiple overtemperature protection in accordance with DIN 12880. This is designed to prevent damage to the chamber load and/or appliance in case of a malfunction:

- electronic temperature monitoring (TWW/TWB) (TWB only if equipped with a second temperature sensor, option A6)
- mechanical temperature limiter (TB)

6.6.2 Electronic Temperature Monitoring

The monitoring temperature of the electronic temperature monitoring is measured via the Pt100 temperature sensor in the chamber. The type of temperature monitoring (TWW/TWB) and the monitoring temperature are set in Menu mode in the **Setup** display (see ▶ 8.3.4 Temperature Monitoring). The setting made applies to all operating modes.

If the manually set monitoring temperature is exceeded, the temperature monitoring system takes over the closed-loop temperature control and starts regulating with reference to the monitoring temperature (TWW) or switches off the heating (TWB).



The two types of temperature monitoring are only available for appliances equipped with a second temperature sensor (option A6). For appliances with only one temperature sensor, only TWW is available.

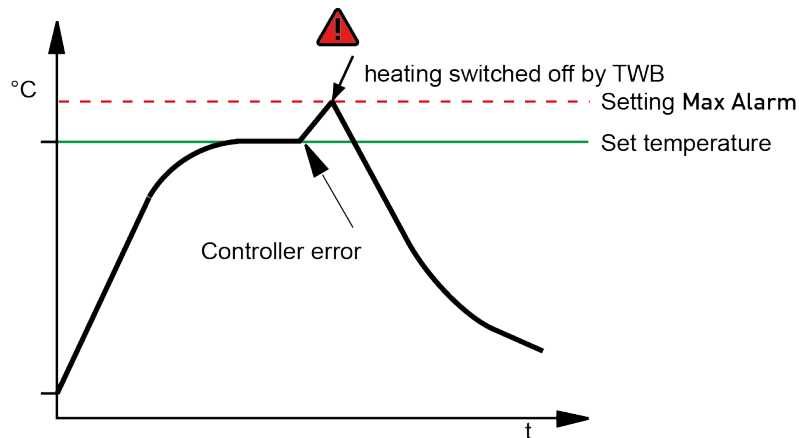
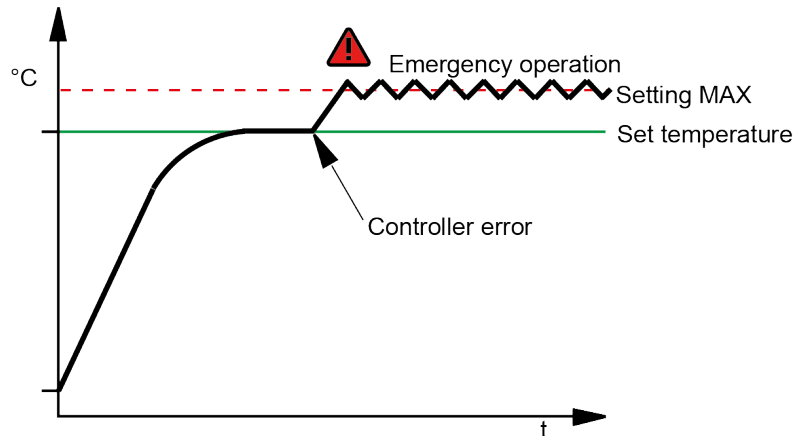

See also

[Temperature Monitoring \[▶ 40\]](#)

6.6.3 Mechanical Temperature Monitoring: Temperature Limiter (TB)

The appliance is equipped with a mechanical temperature limiter (TB) of protection class 1 in accordance with DIN 12880.

If the electronic monitoring unit fails during operation and the factory-set maximum temperature is exceeded by approx. 20 °C, the temperature limiter, as the final protective measure, switches off the heating permanently.

6.7 Ending Operation

⚠ WARNING



Hot surfaces

Depending on the operating situation, the unit and the load may be hot. Contact with hot surfaces may have serious health consequences due to burns!

- Allow the unit to cool down.
- Wear heat-resistant protective gloves when carrying out work.
- Check the temperature of surfaces before touching them.

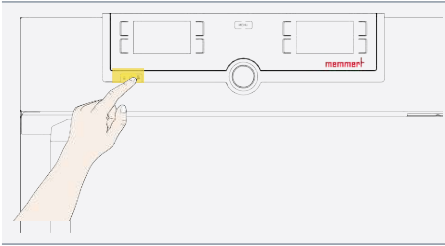

1. Switch off the active unit functions (reset setpoint values).
2. Remove the chamber load.
3. Switch off the unit at the main switch.

7. Malfunctions, Warning and Error Messages

DANGER



Risk of electric shock from unauthorised troubleshooting

Errors requiring intervention inside the unit may only be rectified by qualified electricians.

- Follow the measures listed in the event of a malfunction.
- Contact Memmert International After Sales.

Do not try to rectify appliance errors yourself; instead you should contact Memmert International After Sales or an authorised customer service point.

In case of enquiries, please always state the model and appliance number on the nameplate (see ▶3.6 Nameplate).

See also

Nameplate [▶ 13]

7.1 Warning Message of the Monitoring Function





If the acoustic signal has been activated at Alarm in menu mode (Acoustic Signals, which is indicated by the speaker symbol), the alarm will be accompanied by an intermittent acoustic signal.

The acoustic alarm can be temporarily switched off by pressing the confirmation key until the next alarm event occurs.

7.1.1 Temperature Monitoring

Description	Cause	Action
Temperature alarm and TWW is displayed 	Temperature selector switch (TWW) has taken over the heating control.	<ul style="list-style-type: none"> ■ Increase the difference between the monitoring temperature and the set point temperature – i.e. either increase the max. value of the temperature monitoring or reduce the set point temperature ■ If the alarm persists: Notify customer service
Temperature alarm and TB is displayed 	Mechanical temperature limiter (TB) has switched off the heating permanently.	<ul style="list-style-type: none"> ■ Switch off the appliance and allow it to cool down ■ Contact customer service and have the fault rectified (e.g. replace the temperature sensor)
Temperature alarm and TWB is displayed 	Temperature selector limiter (TWB) has switched off the heating permanently.	<ul style="list-style-type: none"> ■ Switch off the alarm by pressing the confirmation button ■ Increase the difference between the monitoring temperature and the set point temperature – i.e. either increase the max. value of the temperature monitoring or reduce the set point temperature ■ If the alarm persists: Notify customer service

7.2 Malfunctions, Operating Problems and Unit Errors

Error description	Cause of errors	Rectifying errors
Displays are dark 	External power supply was interrupted. Miniature fuse, appliance fuse or power module faulty.	<ul style="list-style-type: none"> Check the power supply Notify customer service
Displays do not activate 	Appliance locked by USER ID. Appliance is in programme, timer or remote control mode ("Write" or "Write + Alarm" mode).	<ul style="list-style-type: none"> Unlock with USER ID Wait for the programme or timer to end or switch off the remote control
Appearance of displays suddenly changes	Appliance is in the "wrong" mode.	<ul style="list-style-type: none"> Press the MENU key to switch to the operating or menu mode
Error message E-3 in the temperature display 	Working and monitoring sensor faulty.	<ul style="list-style-type: none"> Switch off appliance Remove load Notify customer service
Start animation after switching on appears in a colour other than white ●●●.	Cyan ●●●●: not enough storage space on the SD card.	<ul style="list-style-type: none"> Notify customer service
	Red ●●●●: System files could not be loaded.	
	Orange ●●●●: The fonts and images could not be loaded.	

7.2.1 Power Failure

WARNING



Hot surfaces

Depending on the operation performed, the surfaces in the chamber and the chamber load may still be very hot after a power failure. Additionally, depending on the duration of the power failure, the appliance might heat up again after the power supply has been restored. Touching these surfaces can cause burns.

- Wear heat-resistant protective gloves or wait until the appliance cools down first.

In case of a power failure, the unit operates as follows:

In manual mode

After the power supply has been restored, operation is continued with the parameters set. The time and duration of the power failure are documented in the log memory.

In timer or programme mode

In case of an interruption of the power supply of less than 60 minutes, the current programme is continued from the point at which it was interrupted. For longer interruptions of the power supply, all appliance functions are switched off.

After the power supply has been restored, the timer always starts again.

In remote control mode

The previous values are restored. If a programme has been initiated via remote control, it is continued.

8. Menu Mode

In menu mode, you can make basic settings, load programmes and export protocols, as well as adjust the appliance.



Before changing the menu settings, read the description of the respective functions on the following pages to avoid possible damage to the appliance and/or chamber load.



- ▶ To enter Menu mode, press the **MENU** key.
- ⇒ The appliance then returns to operating mode. Only changes applied by pressing the confirmation key are saved.
- ⇒ To exit the menu mode at any time, press the **MENU** key again.

8.1 Overview

Press the **MENU** key to toggle between displays in Menu mode:

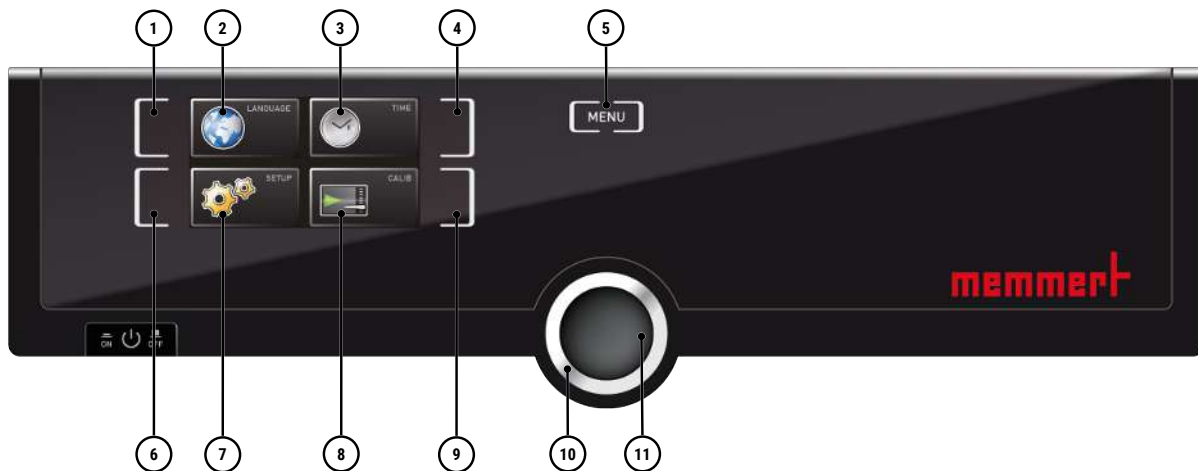

- | | |
|--|---|
| 1 Language selection activation key | 2 Language selection display |
| 3 Date and time display | 4 Date and time setting activation key |
| 5 Return to operating mode | 6 Setup activation key (basic appliance settings) |
| 7 Setup display (basic appliance settings) | 8 Adjustment display |
| 9 Adjustment activation key | 10 Turn control for adjustment |
| 11 Confirmation key (applies setting made with the turn control) | |

8.2 Basic Operation in Menu Mode Using the Example of Language Selection

In general, all settings in Menu mode are made in the same way as operating mode: Activate the respective display, use the turn control for setting and press the confirmation key to apply the change.

A more detailed description of what you need to do is provided below, using the example of language selection. All other settings can be made accordingly. The possible settings are described below.



If no new values are entered or confirmed for approx. 30 seconds, the appliance automatically restores the former values.

	<p>Activate the desired setting (in this example the language):</p> <ol style="list-style-type: none"> To do so, press the activation key to the left or right of the respective display. ⇒ The activated display is enlarged.
	<ol style="list-style-type: none"> If you want to discard the settings or exit the dialogue, press the activation key again. ⇒ The appliance returns to the menu overview. ⇒ Only the settings that you have saved by pressing the confirmation key will be applied.
	<ol style="list-style-type: none"> Select the desired new setting, e.g. Spanish (ESPAÑOL) using the turn control.
	<ol style="list-style-type: none"> Save the setting by pressing the confirmation key.
	<ol style="list-style-type: none"> To return to the menu overview, press the activation key again.
	<p>You can now</p> <ul style="list-style-type: none"> activate another menu function by pressing the corresponding activation key or return to the operating mode by pressing the MENU key.

8.3 Setup

8.3.1 Overview

In the **SETUP** display, you can set the following parameters:

- the IP address and subnet mask of the appliance's Ethernet interface (for connection to a network)
- The units of the temperature display (°C or °F, see ▶8.3.3 Unit)
- The type of temperature monitoring (TWW or TWB, Alarm Temp; see ▶6.6.1 Temperature Monitoring (only if equipped with a second temperature sensor, option A6))
- The trigger temperature of the monitoring function (Max alarm, see ▶6.6.1 Temperature Monitoring)
- The mode of operation of the digital backwards counter with target time setting (Timer Mode, see ▶6.5.2 Digital Backwards Counter)
- The type of shelf (grid or metal panel, see ▶8.3.6 Shelf Type (Grid or metal plate))
- Remote control (see ▶8.3.7 Remote Control)

- Gateway (see ▶8.3.8 Gateway)



If the Setup menu contains more entries than can be displayed, this is indicated by the display “1/2”. This means that there is a second “page” of entries.

To display the hidden entries, use the turn control to scroll beyond the lowest entry. The page display then changes to “2/2”.

See also

- Unit [▶ 40]
- Digital Backwards Counter [▶ 30]
- Shelf Type (Grid or metal plate) [▶ 42]
- Remote Control [▶ 42]
- Gateway [▶ 42]
- Temperature Monitoring [▶ 31]
- Temperature Monitoring [▶ 31]

8.3.2 IP Address and Subnet Mask

If you want to operate one or more appliances in a network, each appliance must have its own unique IP address for identification. By default, each appliance is delivered with the IP address 192.168.100.100.

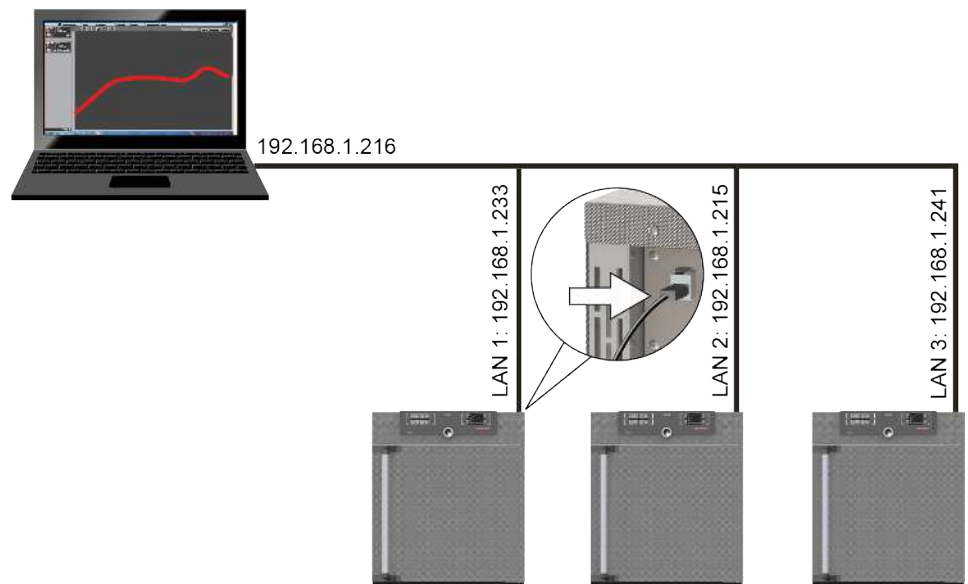

1. Activate the **SETUP** display.

⇒ The **IP address** entry is automatically highlighted.

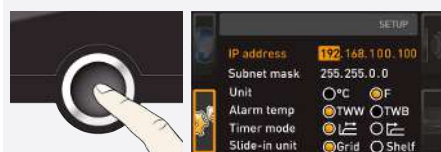

2. Confirm the selection by pressing the confirmation key.

⇒ The first three digits of the IP address are automatically highlighted.

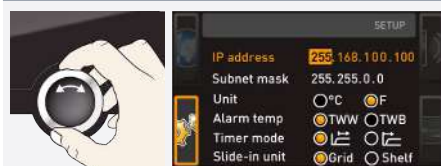

3. With the turn control, set the new number, e.g. 255.



4. Confirm the selection by pressing the confirmation key.
 - ⇒ The next three digits of the IP address are automatically marked.
 - ⇒ They can now also be set according to the description above.



5. After setting the last three digits, confirm the new IP address by pressing the confirmation key.
 - ⇒ The overview is displayed once again.
 - ⇒ The subnet mask can be set in the same way.

8.3.3 Unit



Here, you can choose whether the temperature is displayed in °C or °F.

8.3.4 Temperature Monitoring

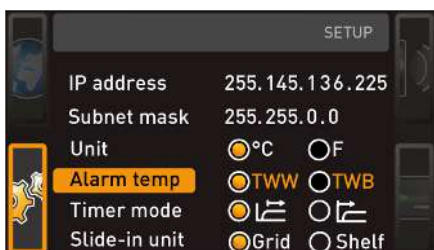

Here, you can choose which temperature protection class in accordance with DIN 12 880:2007-5 should be used (TWW or TWB, description from ▶6.6 Monitoring Function).



The selection option TWW/TWB is only available for appliances with a second temperature sensor (option A6).



The monitoring temperature must be set sufficiently high above the maximum setpoint temperature. We recommend 1 to 3 K difference.



1. Activate the **SETUP** display.
2. Select **Alarm temp** with the turn control.

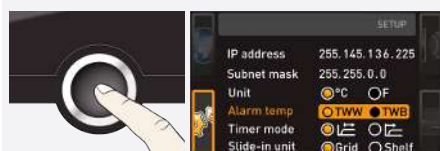

3. Confirm the selection by pressing the confirmation key.
 - ⇒ The adjustment options are automatically highlighted.



4. With the turn control, select the desired temperature monitoring setting – in this example TWB.



5. Save the setting by pressing the confirmation key.

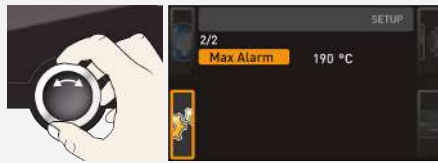

6. Select **Max alarm** with the turn control.



7. Confirm the selection by pressing the confirmation key.
⇒ The current setting is automatically highlighted.

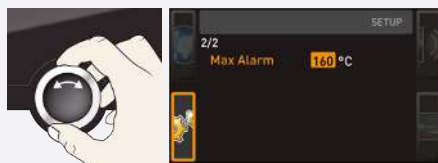

8. With the turn control, select the desired new trigger temperature.



9. Save the setting by pressing the confirmation key.
⇒ The electronic temperature monitoring system will now be triggered when the actual temperature is reached.

See also

- ▣ Monitoring Function [▶ 31]
- ▣ Monitoring Function [▶ 31]

8.3.5 Timer Mode

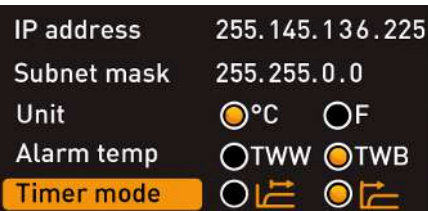

Here, you can choose whether the digital backwards counter with target time setting (see ▶6.5.2 Digital Backwards Counter) should be setpoint-dependent or not – in other words, whether the timer should not start until a tolerance band around the setpoint temperature is reached ⊕ or if it should start right after activation ⊙.

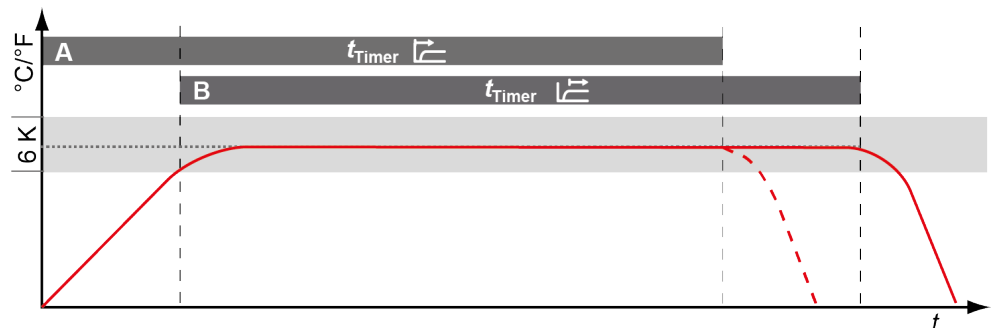

If the temperature goes outside the limits of the tolerance band in setpoint-dependent mode, the timer will be interrupted and only resumed once the temperature is within this band once again.

See also

- ▣ Digital Backwards Counter [▶ 30]

8.3.6 Shelf Type (Grid or metal plate)

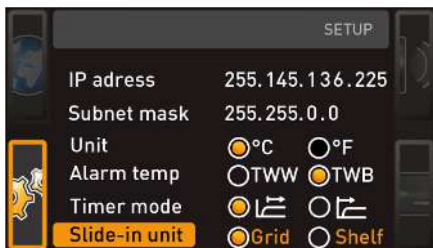

Here, you have to set the type of shelf (grid or metal panel) used. The selection **Metal panel** enables you to adjust the closed-loop control function to the different air flow characteristics in the chamber when using optional shelves instead of the grids provided as standard.

8.3.7 Remote Control

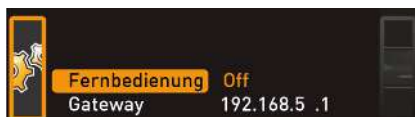

Under the Remote control setup entry, you can set whether the appliance should be controlled via remote control and if so, in which mode. These adjustment options are available:

- Off
- Read Only
- Write + Read
- Write + Alarm

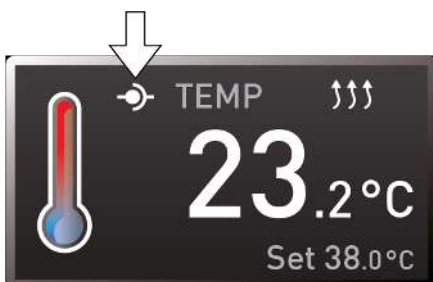

When the appliance is in remote control mode, the  symbol appears in the temperature display. In the settings **Write + Read** and **Write + Alarm**, the appliance cannot be controlled at the ControlCOCKPIT until the remote control has been switched off (**Off** setting) or set to Read Only.

To use the remote control function, programming skills and special libraries are required.

8.3.8 Gateway



The Gateway setup entry is used to connect two networks with different protocols. The gateway is set the same way as the IP address (see ▶8.3.2 IP Address and Subnet Mask).

See also

- 📖 IP Address and Subnet Mask [▶ 39]

8.4 Date and Time

In the **TIME** display, you can set date and time, time zone and summer time. Changes can only be made in manual operating mode.



Always set the time zone (and summer time yes/no) before you set the date and time. Avoid changing the set time after that since this can lead to gaps or overlapping when recording measured values. If you still need to change the time, you should not run a programme immediately before or after doing so.



1. Press the activation key to the right of the **TIME** display.

- ⇒ The display is enlarged and the first adjustment option (**Date**) automatically highlighted.

		2. Turn the turn control until Time zone is highlighted.
		3. Confirm the selection by pressing the confirmation key.
		4. Set the time zone of the installation site with the turn control (e.g. 00:00 for Great Britain, 01:00 for France, Spain or Germany). 5. Confirm the selection by pressing the confirmation key.
		6. With the turn control, select the Summertime entry.
		7. Confirm the selection by pressing the confirmation key. ⇒ The adjustment options are highlighted.
		8. Set summertime to off (X) or on (✓) with the turn control – in this case on (✓). 9. Save the setting by pressing the confirmation key.
	The changeover between summer and winter time does not take place automatically. For this reason, please remember to adjust the setting at the start and end of the summer time.	
		10. Set the date (day, month year) and time (hours, minutes). 11. Confirm the setting by pressing the confirmation key.

8.5 Calibrate

NOTICE



To guarantee problem-free closed-loop control, we recommend calibrating the appliance once a year.

8.5.1 Temperature Calibration

The appliances are temperature calibrated and adjusted at the factory. If readjustment is necessary – for example due to the influence of the chamber load – the appliance can be calibrated for the specific customer using three possible calibration temperatures:

- Cal1 Temperature calibration at low temperature

- Cal2 Temperature calibration at medium temperature
- Cal3 Temperature calibration at high temperature



For temperature calibration, you will need a calibrated reference instrument.

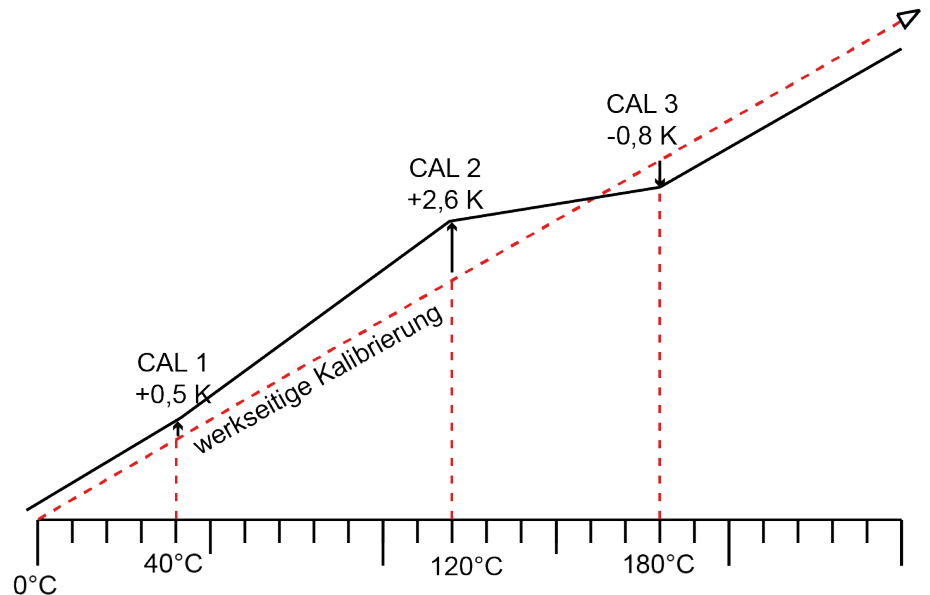

Example: Temperature deviation should be corrected



1. Press the activation key to the right of the **CALIB** display.

⇒ The display is enlarged and the temperature adjustment option is automatically highlighted.



2. Press the confirmation key repeatedly, until the calibration temperature Cal2 is highlighted.

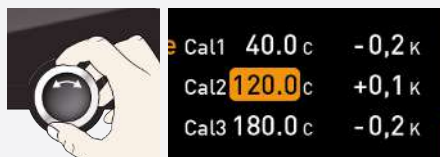

3. With the turn control, set the calibration temperature Cal2 to the specified temperature.

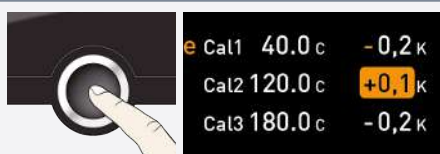



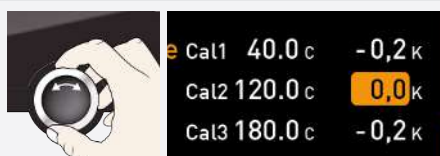

4. Save the setting by pressing the confirmation key.

⇒ The corresponding calibration correction value is automatically highlighted.

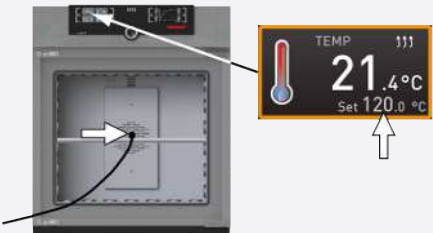

5. Set the calibration correction value to 0.0 K.

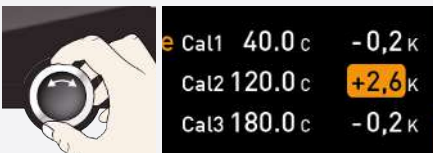
6. Save the setting by pressing the confirmation key.

	<ol style="list-style-type: none"> 7. Position the sensor of a calibrated reference instrument centrally in the working chamber of the appliance. 8. Close the door. 9. In manual mode, adjust the setpoint temperature.
	<ol style="list-style-type: none"> 10. Wait until the appliance reaches and displays the setpoint temperature. <ul style="list-style-type: none"> ■ The reference instrument will display the corresponding deviation.
	<ol style="list-style-type: none"> 11. In the SETUP, adjust the calibration correction value Cal2 to the deviation temperature (actual value measured minus setpoint value). 12. Save the setting by pressing the confirmation key.
	<ol style="list-style-type: none"> 13. Compare the temperature measured by the reference measurement instrument with the temperature displayed on the appliance. <ul style="list-style-type: none"> ⇒ After the calibration procedure, the temperature measured by the reference instrument should now also be the setpoint temperature.

With Cal1, a further calibration temperature below Cal2, and with Cal3 a temperature above, can be programmed in the same manner. The minimum difference between the Cal values is 10 K.



If all calibration correction values are set to 0.0 K, the factory calibration settings are restored.

9. Maintenance and Servicing

⚠ DANGER



Danger of suffocation inside the appliance

If the appliances is a certain size, you can get accidentally locked in, which is potentially life-threatening.

- Do not climb into the appliance.
- Do not carry out cleaning work in the chamber alone.

⚠ DANGER



Live parts

When covers are removed, live parts are exposed and contact with these parts may result in electric shock. Electric shock can have serious health consequences including death.

- Only authorised persons may carry out electrical installation work.
- Before starting work, disconnect the unit from the power supply.
- Ensure that the unit is fully de-energised.
- Secure the unit to prevent it from being switched on again.

⚠ CAUTION



Danger of cuts due to sharp edges

Touching sharp edges on the unit may result in cuts.

- Wear protective gloves during all work.
- Be careful when handling sheet metal parts.

9.1 Cleaning

Interior and metal surfaces

Regular cleaning of the easy-to-clean interior prevents build up of material residues that could impair the appearance and functionality of the stainless steel chamber over time.

The metal surfaces of the appliance can be cleaned with normal stainless steel cleaning agents. Make sure that no rusty objects come into contact with the interior or with the stainless steel housing. Rust deposits can lead to an infection of the stainless steel. If rust spots appear on the surface of the interior due to impurities, the affected area must be immediately cleaned and polished.

Plastic parts

Do not clean plastic parts of the appliance with caustic or solvent-based cleaning agents.

Glass surfaces

Glass surfaces can be cleaned with a commercially available glass cleaner.

9.2 Regular Maintenance

Once a year, grease the moving parts of the doors (hinges and lock) with thin silicone grease and check that the hinge screws are not loose.

To guarantee perfect closed-loop control, we recommend calibrating the appliance once a year (see ▶8.5 Calibrate).

See also

- 📄 Calibrate [▶ 43]

9.3 Repairs and Service

Repairs and service work may only be carried out by specialist Memmert personnel and qualified service providers.

NOTICE



Repairs and service work are described in a separate service manual.

10. Storage, Transport and Disposal

10.1 Storage and Transport

As a manufacturer of products and medical devices, Memmert GmbH + Co. KG provides its dealers and customers with the information required to commission and place the products on the market in accordance with the requirements of Regulation (EU) 2017/745 (hereinafter referred to as 'MDR'). Upon delivery of the product, Memmert GmbH + Co. KG provides you with important information about the product labels.

The appliance may only be stored and transported under the following conditions:

- in a dry enclosed, dust-free room
- disconnected from the power supply

UDI mark on the medical device package as per MDR after the transition period has expired

UDI-DI value	42518175 xxxxxx
UDI-DI allocation body	GS1 Germany GmbH Stolberger Straße 108a 50933 Cologne
Pieces per package	1
Status	On the market

10.2 Disposal



This product is subject to Directive 2012/19/EC on Waste Electrical and Electronic Equipment (WEEE) of the European Parliament and EU Council of Ministers. This unit was placed on the market after 13 August 2005 in countries which have already integrated this Directive into their national laws. It must not be disposed of as normal household waste. For disposal, please contact your dealer or the manufacturer. Any units that are infected, infectious or contaminated with materials hazardous to health are excluded from return. Please also observe all other regulations applicable in this context.

Before disposing of the appliance, please render the door locking mechanism unusable, for example to prevent playing children playing with the appliance and being locked inside.

There is a lithium battery in the ControlCOCKPIT of the appliance. Remove it and dispose of it in accordance with the regulations in your country.

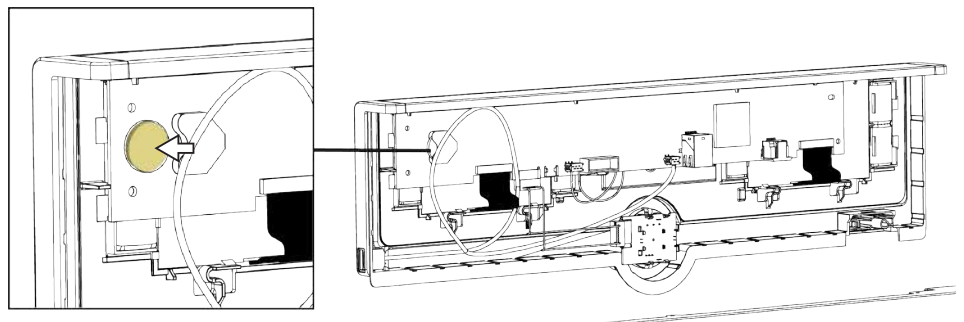

Note for Germany:

- The appliance may not be left at public or municipal collection points.

Incubator I
SingleDISPLAY

Operating manual
D53194 Effective 04/2025
English

